



2 -

(,) 2 -
 (3),
 .2.
 2 -
 2 - , .5523.083 .
 1.

.5523.083

2	4	14	()
: - ; - () .18; -			

« » (« »)







2 - 4/14 .5523.083
 2 - 4/14 .5523.083

1,0	50
	5 000
	. . 1
()	. . 1
-	500
	10 000
	6

	:		:
:	1 – 500	,	60
, / ² (g)	100 (10)	,	60
:		,	
, / ² (g)	1 500 (150)	(. .)	5,3*10 ⁴ (400)
:			
, / ² (g)	400 (40)		

	,	,
10000		100
15000		93
20000		89
25000		86
30000		83
40000		79
50000		71
80000		70
100000		67
130000		64

	, %	,
90		28
80		27
70		25
60		23
50		20
40		18

2 -	14				1,0	4	1	5	20	500
2 -	14				1,0	4	-	7,5	30	500

2 -

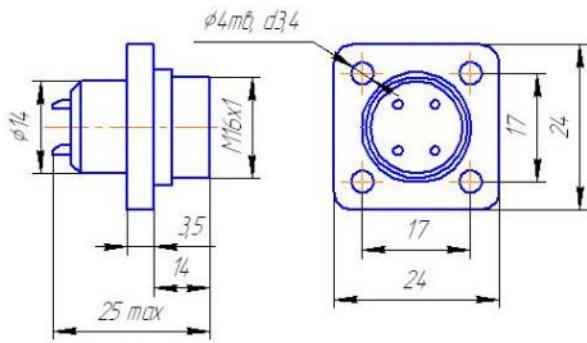

2 -

